

PowerAmp Design

HIGH POWER OPERATIONAL AMPLIFIER

PAD128

Rev D

KEY FEATURES

- LOW COST
- HIGH VOLTAGE – 100 VOLTS
- HIGH OUTPUT CURRENT – UP TO 30A
- 140 WATT DISSIPATION CAPABILITY
- 300 WATT OUTPUT CAPABILITY
- WIDE SUPPLY RANGE $\pm 10V - \pm 50V$
- INTEGRATED HEAT SINK AND FAN
- TEMPERATURE REPORTING
- OVER-TEMPERATURE SHUTDOWN
- RAIL TO RAIL CAPABLE WITH PAD130 ACCESSORY MODULE

APPLICATIONS

- LINEAR MOTOR DRIVE
- INDUSTRIAL (PA) AUDIO
- SEMICONDUCTOR TESTING
- VIBRATION CANCELLATION
- MAGNETIC BEARINGS

DESCRIPTION

The PAD128 high power operational amplifier is constructed with surface mount components to provide a cost effective solution for many industrial applications. With a footprint only 5.6 in² the PAD128 offers outstanding performance that rivals much more expensive hybrid component amplifiers or rack-mount amplifiers. User selectable external compensation tailors the amplifier's response to the application requirements. The PAD128 also features a substrate temperature reporting output and over-temp shutdown. The amplifier achieves rail to rail operation with the addition of the optional PAD130 Power Supply Accessory Module. The amplifier circuitry is built on a thermally conductive but electrically insulating substrate mounted to an integral heat sink and fan assembly. No BeO is used in the amplifier. The resulting module is a small, high performance turn-key solution for many industrial applications.

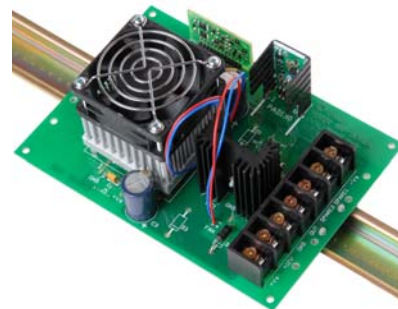

PAD128 MOUNTED IN EVALUATION KIT

A NEW CONCEPT

A critical task in any power amplifier application is cooling the amplifier. Until now component amplifier manufacturers often treated this task as an after-thought, left for the user to figure out. At **Power Amp Design** the best heat sink and fan combination is chosen at the start and becomes an integral part of the overall amplifier design. The result is the most compact and volumetric efficient design combination at the lowest cost. In addition, this integrated solution concept offers an achievable real-world power dissipation rating, not the ideal rating usually cited when the amplifier case is somehow kept at 25°C. The user no longer needs to specify, procure or assemble separate components.

PowerAmp Design ♦ PAD128 ♦ HIGH POWER OPERATIONAL AMPLIFIER

EQUIVALENT CIRCUIT

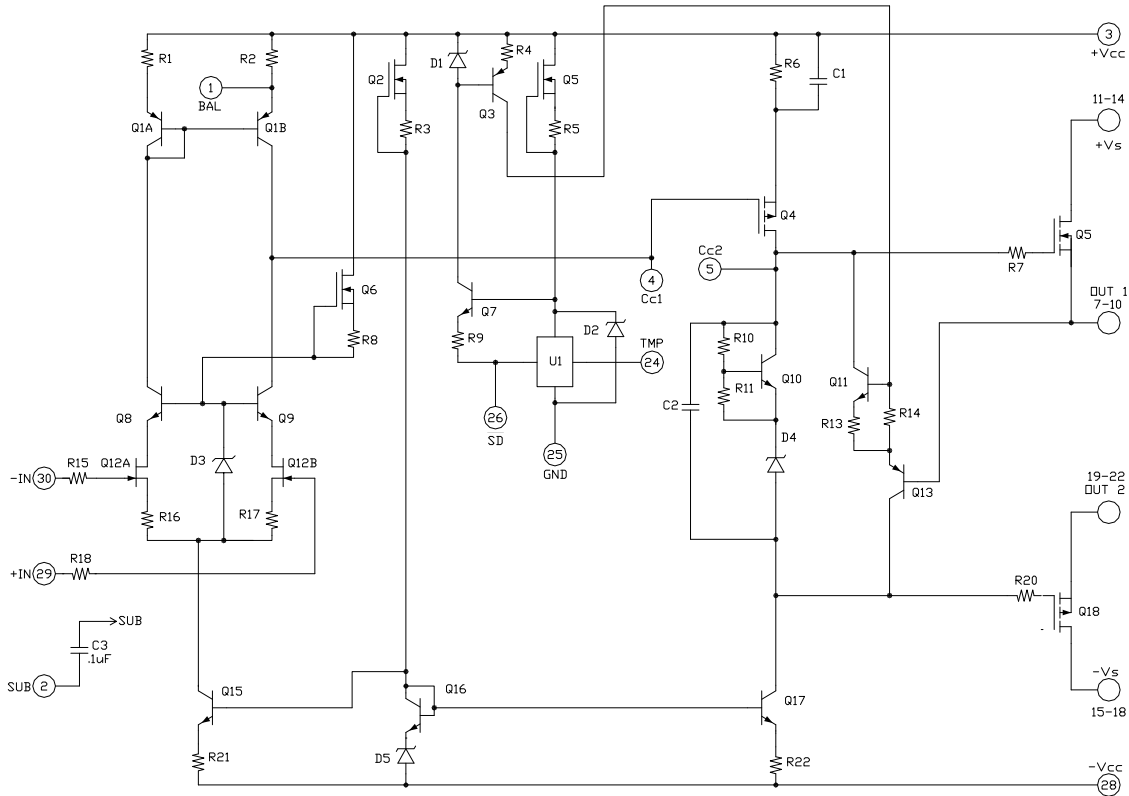

AMPLIFIER PINOUT & CONNECTIONS

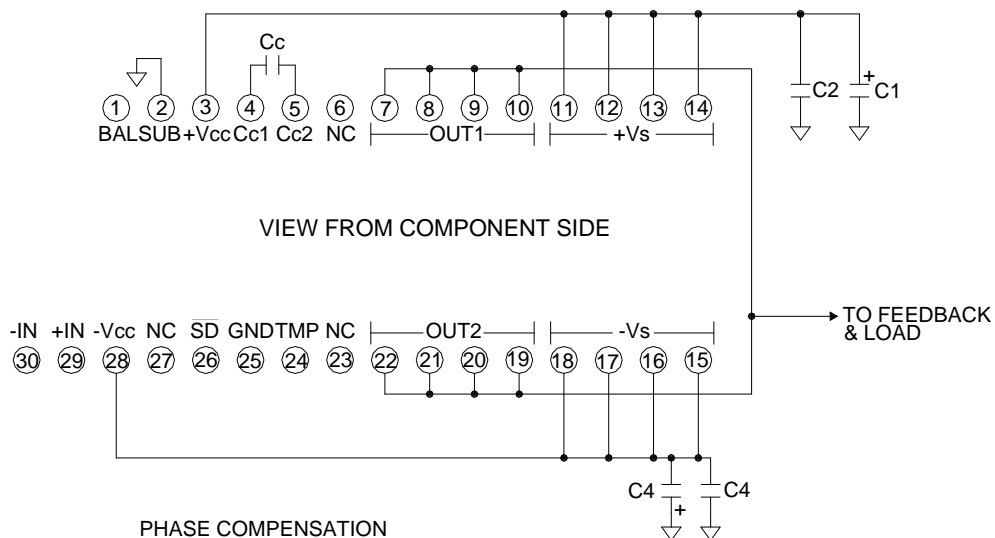

PHASE COMPENSATION

GAIN	Cc	SLEW V/uS
1	470pF	3.5
≥10	100pF	16

* SEE APPLICATION CIRCUITS FOR OTHER CONNECTIONS AND FUNCTIONS.

ABSOLUTE MAXIMUM RATINGS			
SUPPLY VOLTAGE, +Vs to -Vs	100V	INPUT VOLTAGE	+Vcc to -Vcc
SUPPLY VOLTAGE +Vcc to -Vcc	120V ⁷	DIFFERENTIAL INPUT VOLTAGE	± 20V
OUTPUT CURRENT, peak	30A, within SOA	TEMPERATURE, pin solder, 10s	300°C
POWER DISSIPATION, internal, DC	140W	TEMPERATURE, junction ²	150°C
OPERATING TEMPERATURE, heat sink	-40 to +105°C	TEMPERATURE RANGE, storage	-40 to 70°C ⁵

PARAMETER	TEST CONDITIONS ¹	MIN	TYP	MAX	UNITS
INPUT					
OFFSET VOLTAGE			1	5	mV
OFFSET VOLTAGE vs. temperature	Full temperature range		20	50	μV/°C
OFFSET VOLTAGE vs. supply				20	μV/V
BIAS CURRENT, initial ⁵				100	pA
BIAS CURRENT vs. supply				0.1	pA/V
OFFSET CURRENT, initial				50	pA
INPUT RESISTANCE, DC			100		G Ω
INPUT CAPACITANCE			4		pF
COMMON MODE VOLTAGE RANGE		+Vcc-10			V
COMMON MODE VOLTAGE RANGE		-Vcc+6			V
COMMON MODE REJECTION, DC		92			dB
NOISE	100kHz bandwidth, 1kΩ R _s		10		μV RMS
SHUTDOWN (SD)	Grounded			1	mA
GAIN					
OPEN LOOP	R _L = 100Ω, C _C =100pF	108			dB
GAIN BANDWIDTH PRODUCT @ 1MHz	C _C =100pF		1		MHz
PHASE MARGIN	Full temperature range	60			degree
OUTPUT					
VOLTAGE SWING	I _O = 20A	+Vs-6.1			V
VOLTAGE SWING	I _O = -20A	-Vs+6.1			V
CURRENT, continuous, DC		20			A
CURRENT, peak within SOA				30	A
SLEW RATE, A _v = -10	C _C = 100pF	13	16		V/μS
SETTLING TIME, to 0.1%	2V Step		2		μS
RESISTANCE	No load, DC, open loop		4		Ω
POWER SUPPLY					
VOLTAGE ⁷		± 10	± 35	± 50	V
CURRENT, quiescent			41.6	52	mA
THERMAL					
RESISTANCE, AC, junction to air ⁴	Full temperature range, f ≥ 60Hz			0.7	°C/W
RESISTANCE, DC, junction to air	Full temperature range			0.9	°C/W
TEMPERATURE RANGE, heat sink		-40		105	°C
FAN, 60mm dc brushless, ball bearing					
OPERATING VOLTAGE			12		V
OPERATING CURRENT			150		mA
AIR FLOW			25		CFM
RPM			3800		RPM
NOISE			30		dB
L10, life expectancy, 50°C ⁶			45		kHrs
L10, life expectancy, 25°C ⁶			60		kHrs

NOTES:

1. Unless otherwise noted: T_c=25°C, compensation C_c=470pF, DC input specifications are ± value given, power supply voltage is typical rating.
2. Derate internal power dissipation to achieve high MTBF.
3. Doubles for every 10°C of case temperature increase.
4. Rating applies if the output current alternates between both output transistors at a rate faster than 60Hz.
5. Limited by fan storage characteristics. During operation, even though the case may be at 85°C the fan will be at a lower temperature.
6. L10 refers to the time it takes for 10% of a population of fans to fail.
7. +Vcc and -Vcc must not be more than 20V greater than +Vs and -Vs respectively

COOLING FAN

The PAD128 relies on its fan for proper cooling of the amplifier. Make sure that air flow to the fan and away from the heat sink remains unobstructed. The cooling method used is impingement cooling, which means that cool air is pushed into the heat sink and warm air is exhausted through the spaces between the heat sink fins. To eliminate electrical noise created by the cooling fan we recommend a 47 μ F capacitor placed directly at the point where the fan wires connect to the PCB. See application note AN-24 for further details.

MOUNTING THE AMPLIFIER

The amplifier is supplied with four 4-40 M/F hex spacers at the four corner of the amplifier. Since the male threaded ends of the spacers extend beyond the amplifier pins the spacers provide a convenient alignment tool to guide the insertion of the amplifier pins into the circuit board. Once the amplifier is seated secure the module with the provided 4-40 nuts and torque to 4.7 in lb [53 N cm] max. See “**Dimensional Information**” for a detailed drawing. It is recommended that the heat sink be grounded to the system ground. This can easily be done by providing a grounded circuit board pad around any of the holes for the mounting studs.

TEMPERATURE REPORTING

An analog output voltage is provided (pin 24, TMP) relative to ground (pin 25) and proportional to the temperature in degrees C. The slope is approximately -10.82mV/°C. The output voltage follows the equation:

$$T = (2.127 - V) (92.42)$$

Where V is the TMP output voltage and T is the substrate temperature in degrees C.

This high impedance output circuit is susceptible to capacitive loading and pickup from the output of the amplifier. When monitoring TMP filter the voltage as shown in Figure 3. See **Applications Circuits**.

THERMAL SHUTDOWN

The temperature monitoring circuit automatically turns off the output transistors when the substrate temperature reaches 110°C. When the substrate cools down 10°C the output is enabled once again. The thermal shutdown feature is activated either by amplifier overloads or a failure of the fan circuit.

EXTERNAL SHUTDOWN

When pin 26 (\overline{SD}) is taken low (ground) the output stage is turned “off” and remains “off” as long as pin 26 is low. When pin 26 is monitored with a high impedance circuit it also functions as a flag, reporting when the amplifier is shut down.

A “high” (+5V) on pin 26 indicates the temperature is in the normal range. A “low” (ground) indicates a shutdown condition. See **Application Circuits** for details on how to implement an external shutdown circuit and how to monitor the shutdown status.

CURRENT LIMIT

The PAD128 does not have a current limiting circuit built in. However, a Current Limit Accessory Module, model PAD125, is available if the current limiting function is needed for the application. See the PAD125 data sheet and **Application Circuits** for a typical connection diagram.

RAIL TO RAIL OPERATION

Rail to rail input and output operation is implemented by adding two additional external power supplies to the amplifier circuit. One power supply is set to be +Vs+10V and is connected to the +Vcc pin. The other additional power supply is set to be -Vs-10V and is connected to the -Vcc pin. See Figure 3 in **Application Circuits**. An accessory module, model PAD130, provides a convenient compact power supply for this purpose. See the data sheet for the PAD130. See also application note AN10, *The Rail to Rail Advantage*.

PHASE COMPENSATION

The PAD128 **must** be phase compensated to operate correctly. The compensation capacitor, C_C, is connected between pins 4 and 5. On page 6, Typical Performance Graphs, you will find plots for small signal response and phase response using compensation values of 100pF and 470pF. The compensation capacitor must be an NPO type capacitor rated for the full supply voltage (100V). On page 2, under Amplifier Pinout and Connections, a table gives recommended compensation capacitance values for various gains and the resulting slew rate for each capacitor value.

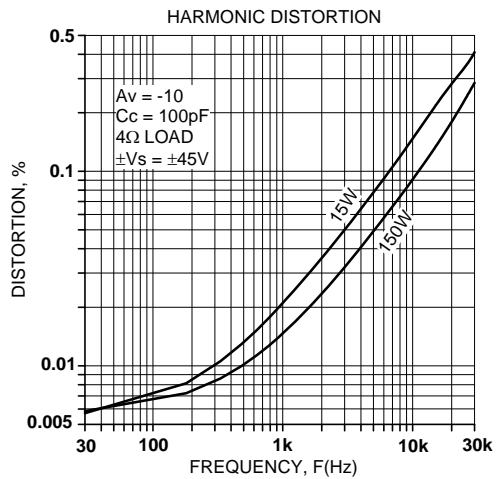
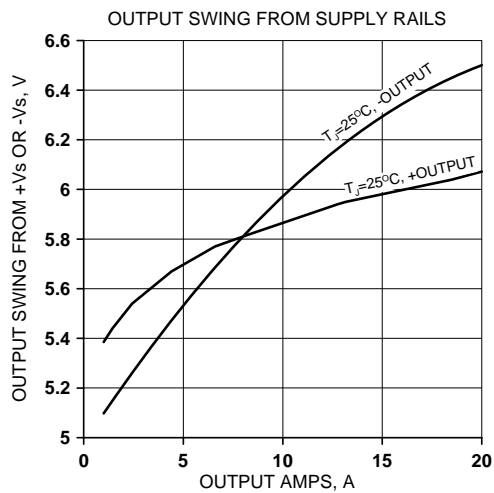
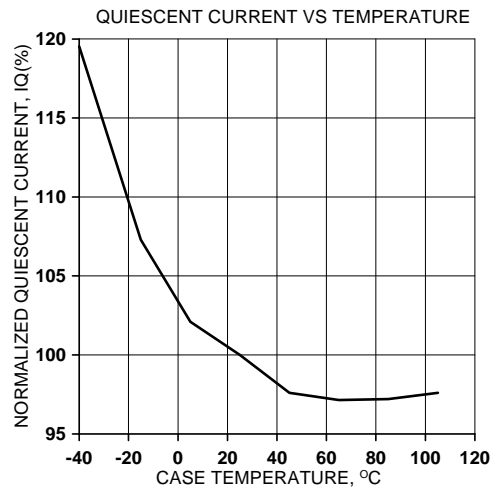
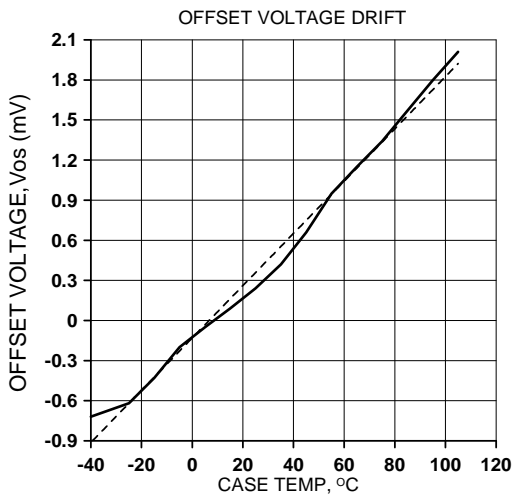
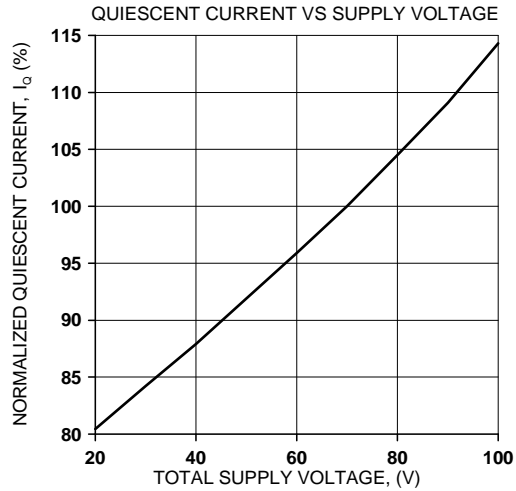
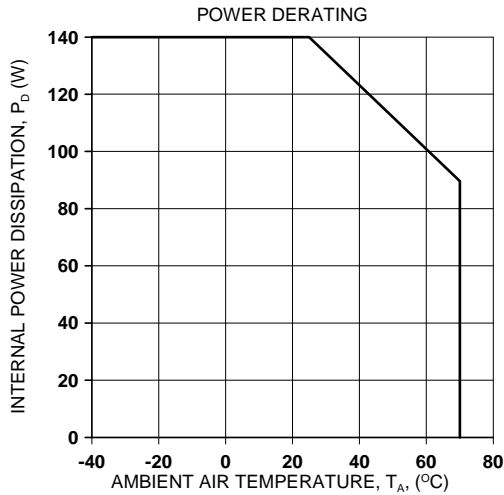

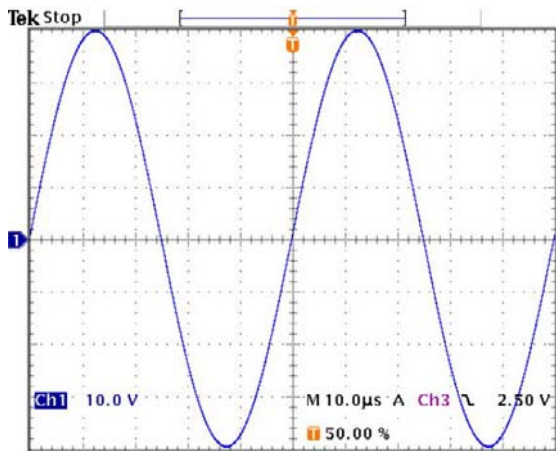
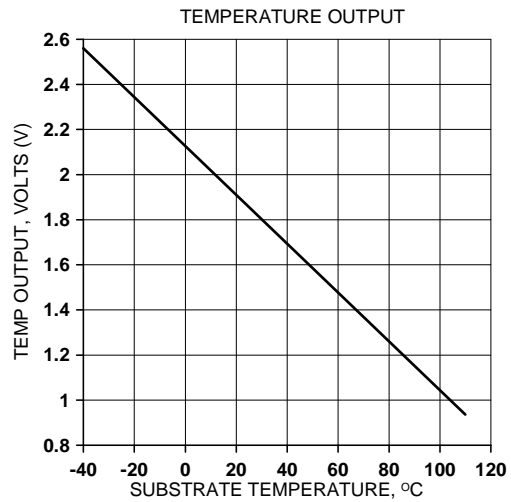
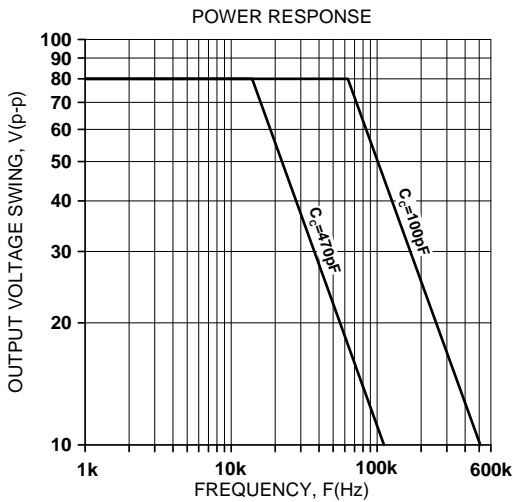
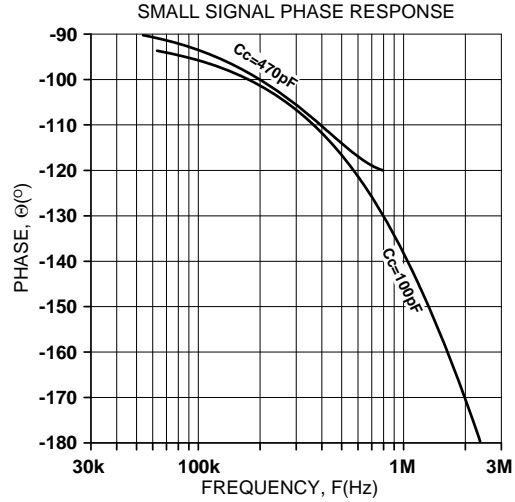
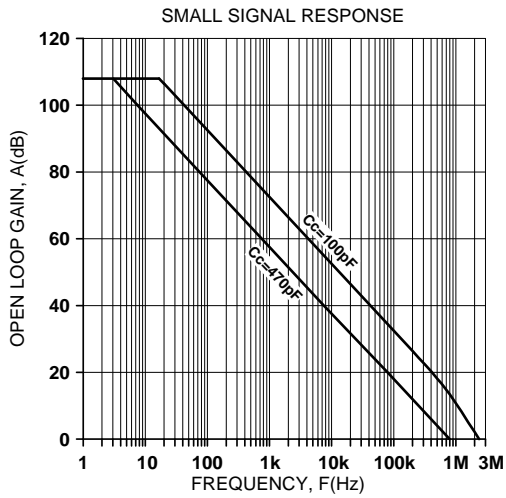

80Vp-p 20kHz into 4 Ω load, G=-10, Cc=100pF

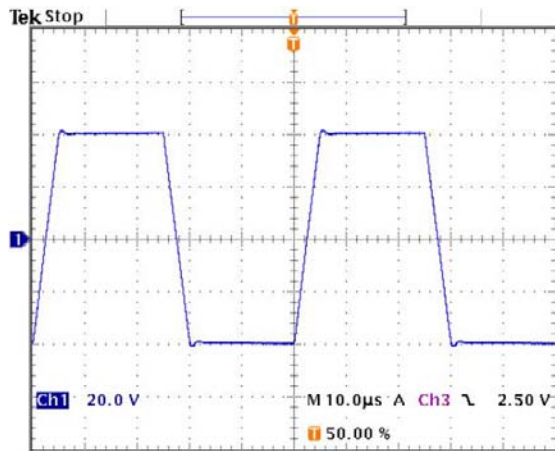

20kHz square response, 80Vp-p, 4 Ω load, G=-10, Cc=100pF

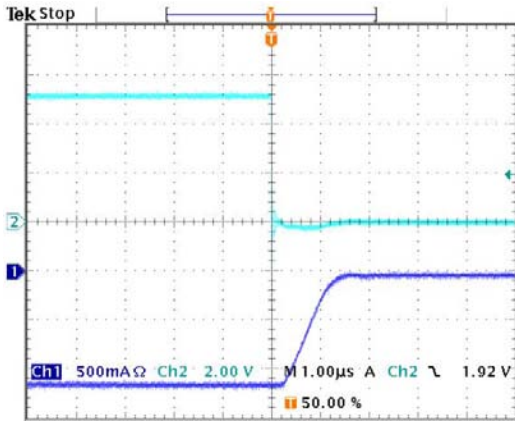

SHUTDOWN RESPONSE, NEGATIVE OUTPUT TO ZERO TRANSITION

The oscilloscope display at the left shows an expanded view of a 1kHz 1.2A p-p amplifier output signal being interrupted near the negative peak by a shutdown signal on Ch2. The Ch1 display shows the output *current* going to zero about 1.5μS after the shutdown signal goes low.

SHUTDOWN RESPONSE, POSITIVE OUTPUT TO ZERO TRANSITION

The oscilloscope display at the right shows an expanded view of a 1kHz 1.2A p-p amplifier output signal being interrupted near the positive peak by a shutdown signal on Ch2. The Ch1 display shows the output *current* going to zero about 2.5μS after the shutdown signal goes low.

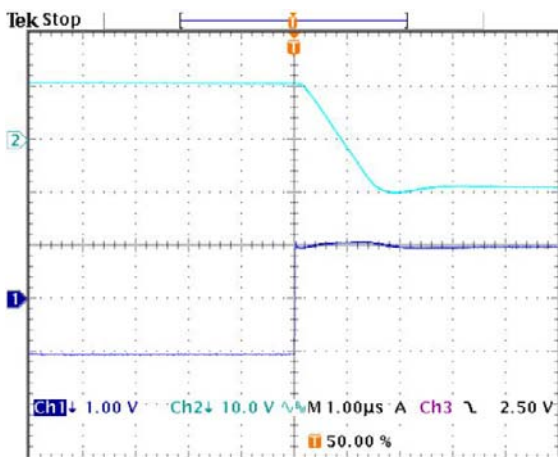
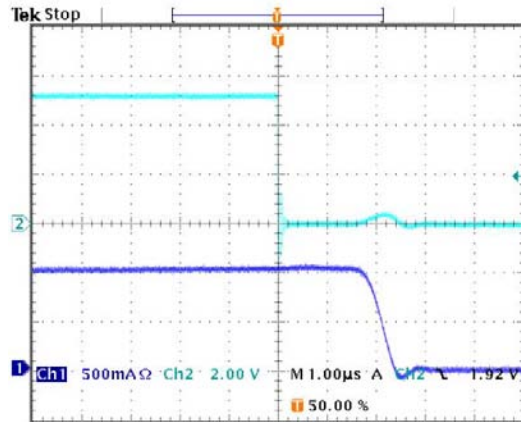

Pulse Response, Positive to Negative, 4Ω Load
G=-10, Cc=100pF

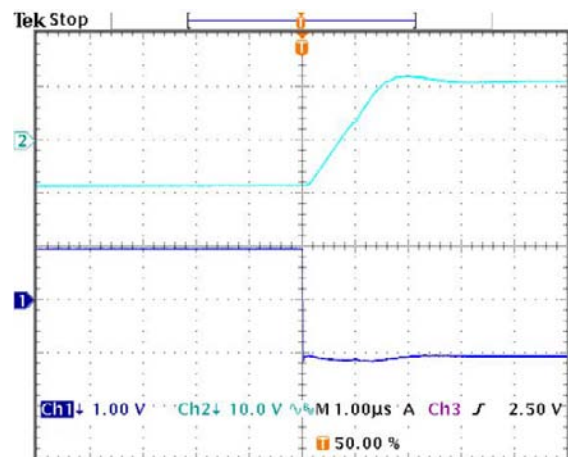

Pulse Response, Negative to Positive, 4Ω Load
G=-10, Cc=100pF

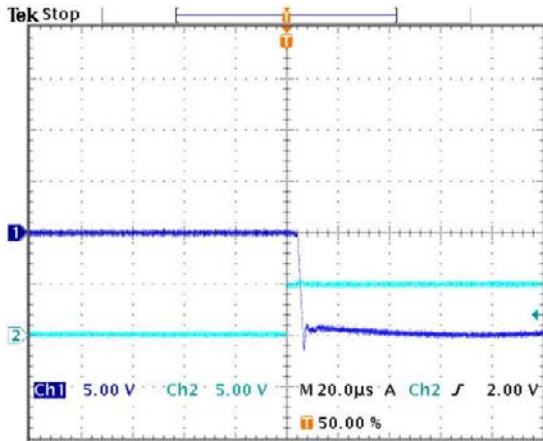

SHUTDOWN RECOVERY, ZERO TO NEGATIVE TRANSITION

The oscilloscope display at the left shows an expanded view of the PAD128 recovering from a shutdown condition and resuming the negative portion of a 1kHz 5Ap-p amplifier output signal on Ch1. The Ch2 display shows shutdown signal going high (no shutdown). The amplifier recovers from the shutdown condition in about 10µS.

SHUTDOWN RECOVERY, ZERO TO POSITIVE TRANSITION

The oscilloscope display at the right shows an expanded view of the PAD128 recovering from a shutdown condition and resuming the portion of a 1kHz 5Ap-p amplifier output signal on Ch1. The Ch2 display shows shutdown signal going high (no shutdown). The amplifier recovers from the shutdown condition in about 30µS.

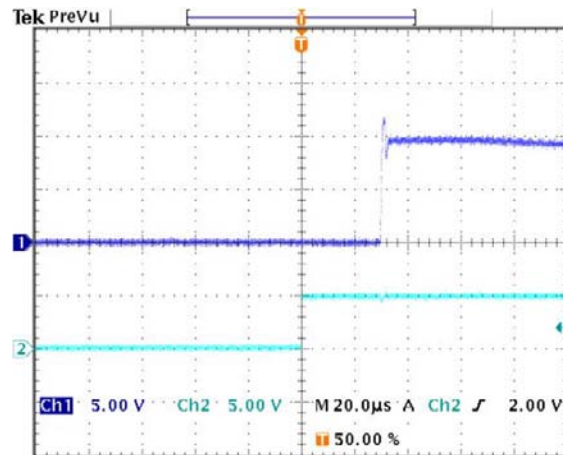

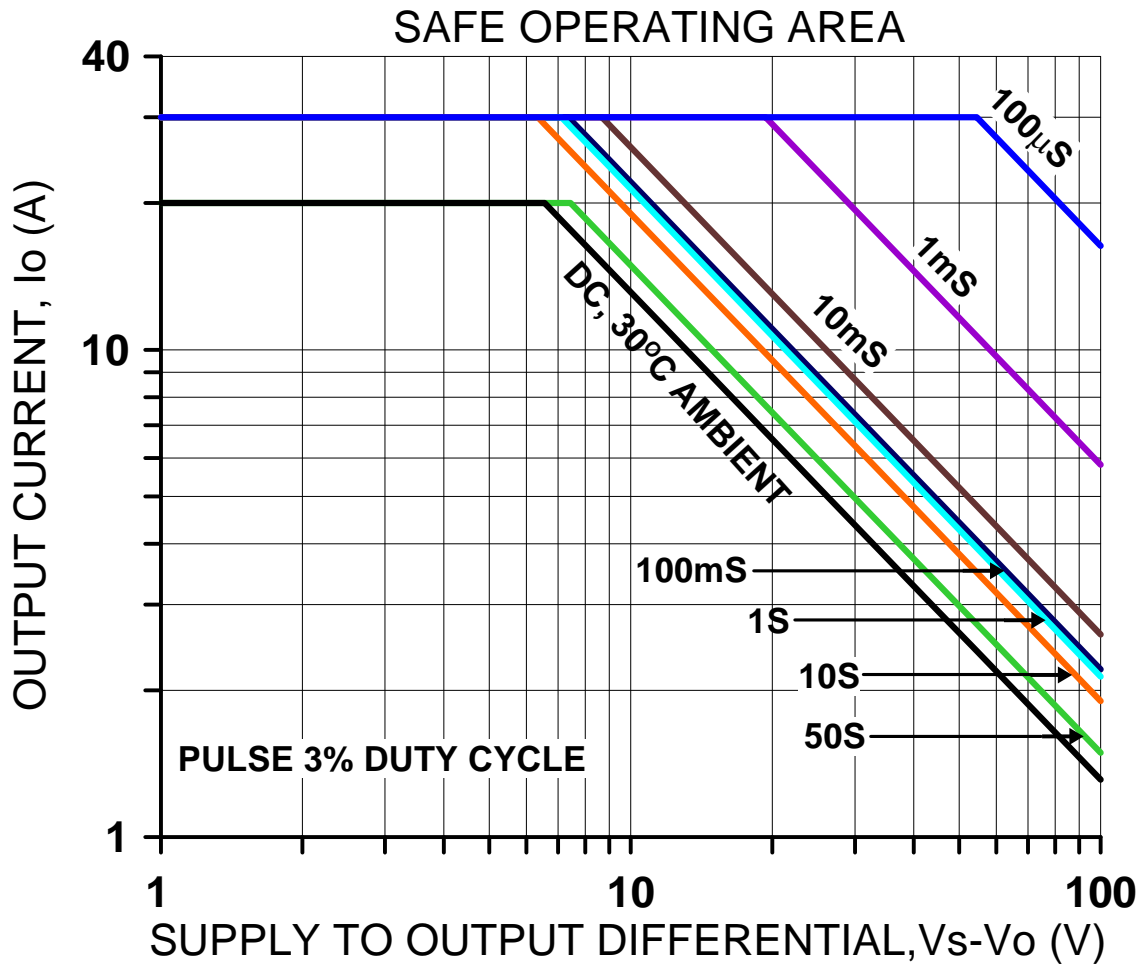

SAFE OPERATING AREA

The safe operating area (SOA) of a power amplifier is its single most important specification. The SOA graph presented above serves as a first approximation to help you decide if the PAD128 will meet the demands of your application. But a more accurate determination can be reached by making use of the **PAD Power**™ spreadsheet which can be found in the *Power Amp Design* website under the *Design Spreadsheet* tab. While the graph above adequately shows DC SOA and some pulse information it does not take into account ambient temperatures higher than 30°C, AC sine, phase or non-symmetric conditions that often appear in real-world applications. The **PAD Power**™ spreadsheet takes all of these effects into account.

PowerAmp Design ♦ PAD128 ♦ HIGH POWER OPERATIONAL AMPLIFIER

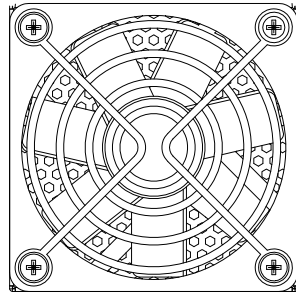

NOTES:

1. PINS .0025" SQUARE X30
2. RECOMMENDED HOLE FOR MOUNTING 0.129" X4
3. RECOMMENDED HOLE FOR PINS 0.052" D.
4. TOTAL ASSEMBLY WEIGHT APPROX 8.1 oz [230 g]
5. HEAT SINK WEIGHT APPROX 4.55 oz [129 g]

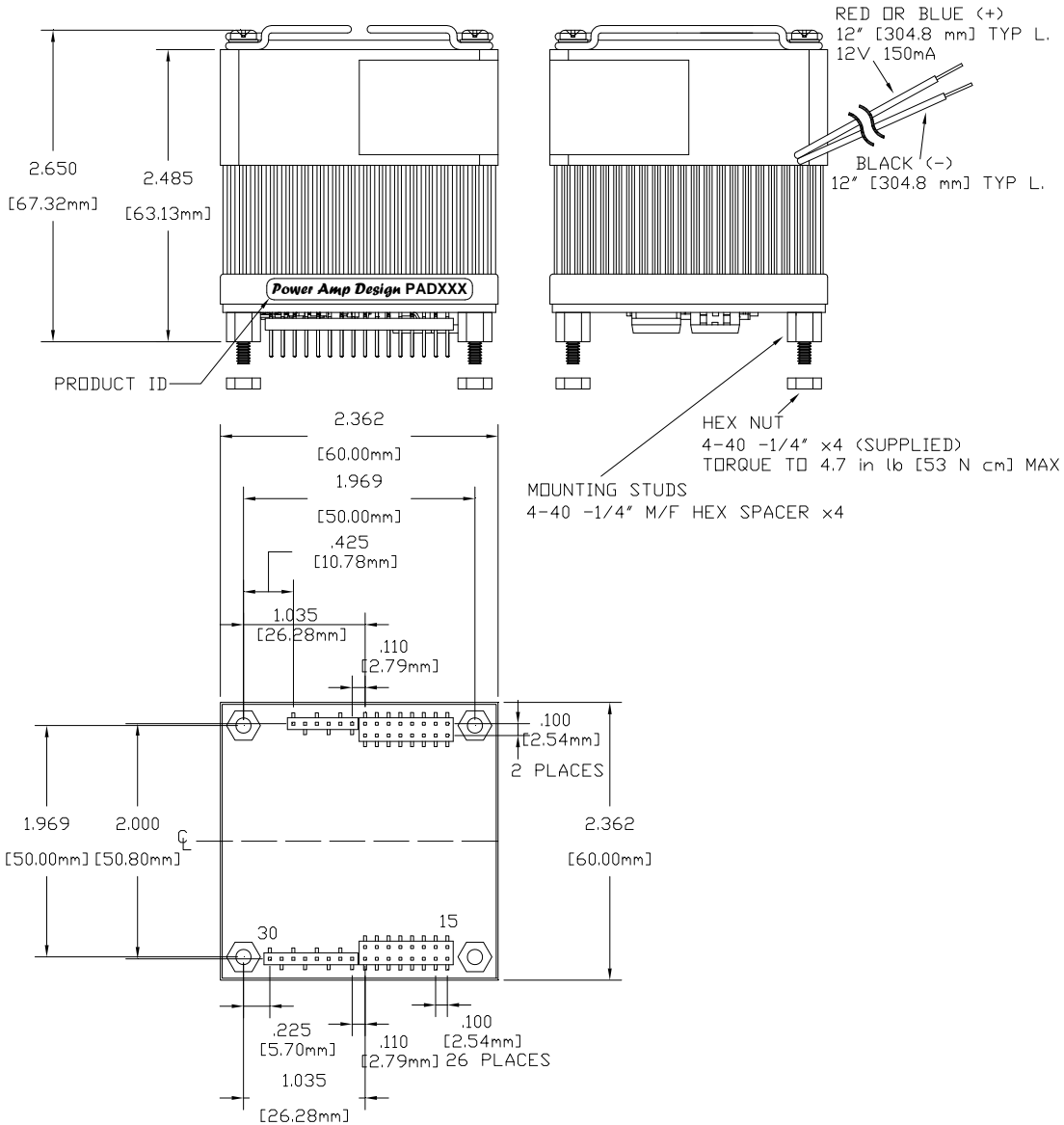

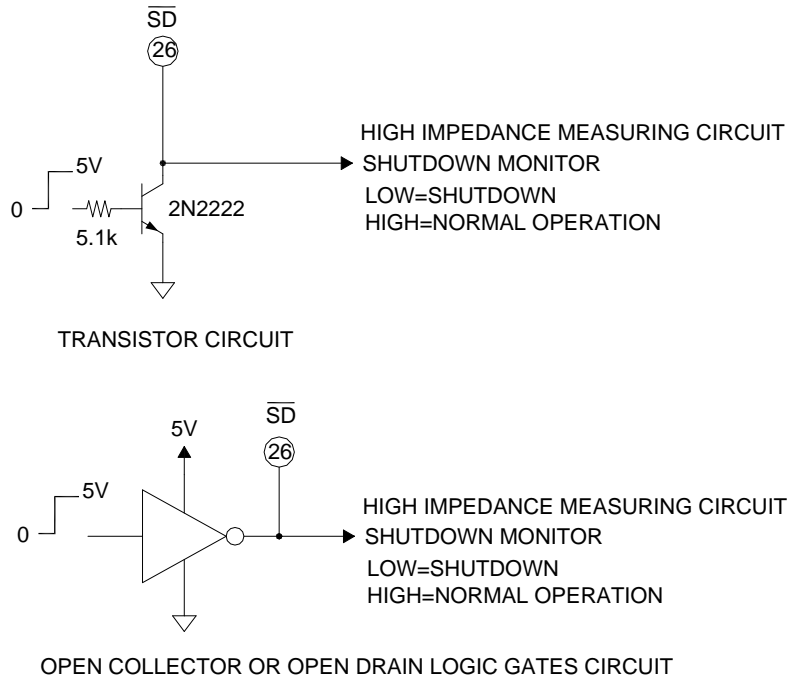

FIGURE 1.
EXTERNAL SHUTDOWN WITH MONITOR

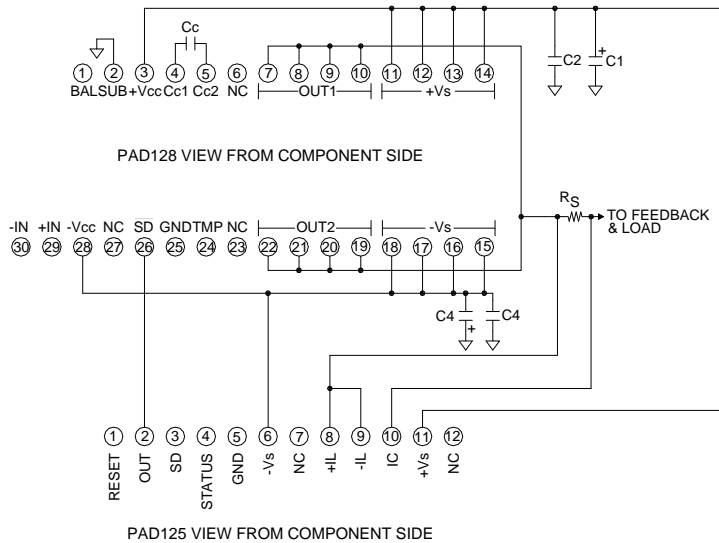

FIGURE 2.
TYPICAL PAD128 CONNECTIONS TO PAD125 ACCESSORY MODULE

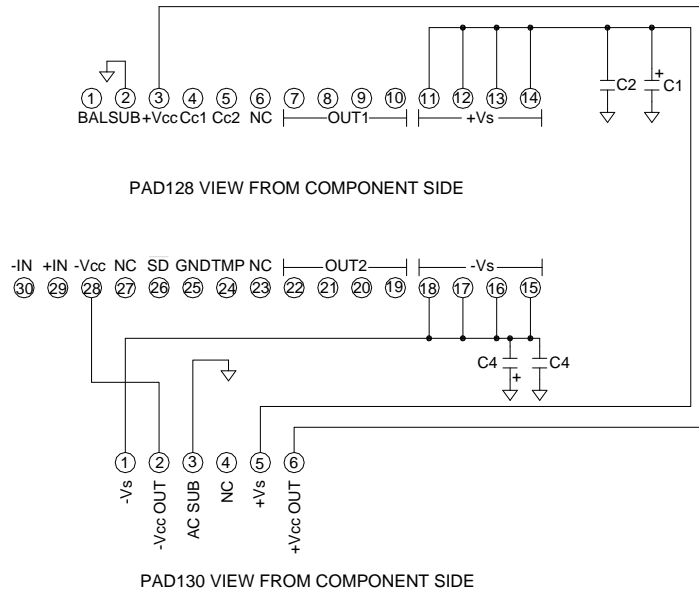

FIGURE 3.
IMPLEMENTING RAIL TO RAIL OPERATION USING PAD130 ACCESSORY MODULE